

## Letter Shapes - Building Alphabet Letters

This activity includes a set of shapes - lines, curves, and circles - that can be used to build the letters of the alphabet. The exercise is designed to help students notice and become familiar with the parts of each letter. It is a puzzle type of activity. Students put together circles, lines, and curves to form the letters. While students are learning, pieces are placed on an outline of the letter. Then students practice building the letters without the outlines.

The shapes should be run off on pastel colored cardstock (using the colors listed below), laminated, and cut out. You will need very small, sharply pointed scissors to cut out the middle of the circles. There are four sets of letters. To make it easier to find the pieces you need, each different set is printed on a separate color of card stock. Store each set of pieces in a separate envelope, plastic bag, or box.

The slanted lines come in various lengths. To help you find the correct line more easily, they are labeled with the name of the letter in which they should be used. After you find the pieces you need, turn them over, so that the labels don't show when you build the letter.

Set 1	Short Letters	Red	a, c, e, i, m, n, o, p, r, s, u
Set 2	Letters With Tails	Purple	g, j, qu
Set 3	Tall Letters	Blue	b, d, f, h, k, l, t
Set 4	Letters With Slanted Lines	Green	v, w, x, y, z

There are three kinds of lined pages for building the letters. These should be printed on white card stock. The first kind has the letters grouped in sets as listed above. Only one set at a time will be used. These are the easiest, since the number of pieces used is restricted and all the pieces in the set are the same color. Students will find the needed shapes to form the letter, and place each piece directly on the matching outline. Notice that there is some overlap with the shapes when forming the letter.

The second kind of lined page shows the letters in alphabetical order. These will be more challenging, since the student will need to find the pieces from all of the sets listed above.

The third kind of pages are lined but do not have letter outlines. When ready, students can build letters on the lines without the outlines to guide them.

## Warm-Up 1 - Become Familiar With The Shapes

Start with a series of warm-up activities. Work with the student to separate the shapes into lines, circles, and curves. Talk about the name of each shape and its properties. Some of the lines are longer than others. Sort the lines by length.

## Warm-Up 2 - Play A Copying Game

Next play a copying game. The teacher takes two shape pieces and gives two identical pieces to the student. For instance, you may want to start with a line and a circle. Make a design, using the two shapes, and have the student copy it exactly. Continue to form a variety of designs with the same two pieces and have the student match each configuration. Point out any errors and have the student try again. The series of designs might look something like this. Verbally describe the various positions of the pieces. "The line is above the circle. The line is below the circle."

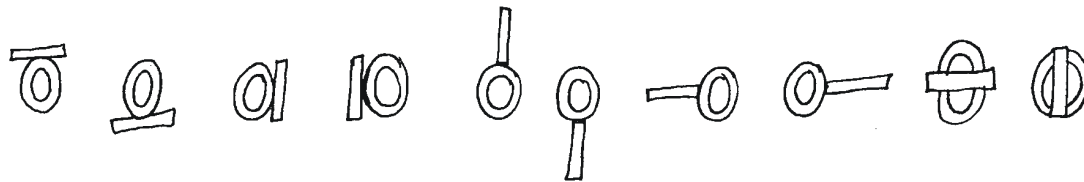

During the following lessons, choose pieces in a variety of different shapes and sizes to work with, and gradually make the designs more challenging. You may also want to let the student make some of the designs for the teacher to copy. Here are some samples of designs to copy using two lines.

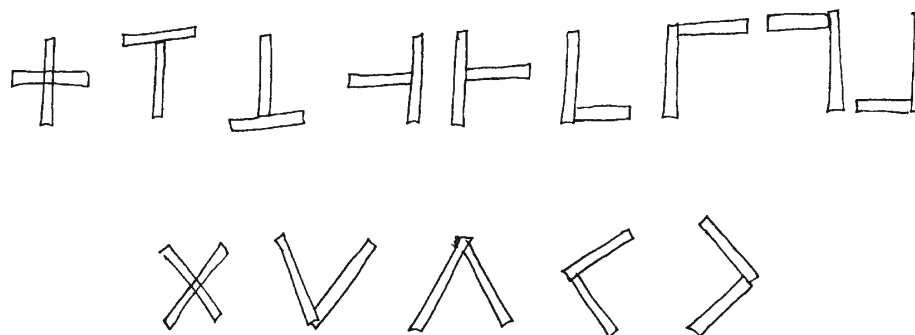

## **Use The Circles, Lines, And Curves To Build Letters**

Now it is time for the student to use the shapes to form letters. You'll build the letters on lined pages showing the outline of each letter.

As you introduce a new letter, get out the appropriate page and the pieces needed to build the letter. Lay the pieces to the side, and have the student put the pieces on the outline to assemble the letter. Have the student verbalize which shapes are used and describe how they are arranged. Have the student say the sound represented by the letter. Then have the student reassemble the letter on the plain lined paper, without using the outline. Finally, cover the card with the outline and see if the student can build the letter from memory.

After one or more new letters have been introduced, have students practice rebuilding previously learned letters.

## **Work On Several Letters At Once**

After students have mastered each letter individually, select several pages with letter outlines, and have the student find and place all of the pieces.

Finally, let students build the whole alphabet on the lined pages with no outlines.

## **Acknowledgments**

This activity was adapted from the Ball-Stick-Bird program by Renee Fuller, Ph.D. See <http://www.ballstickbird.com/>

z

z

v

v

w

w

w

w

y

y

Print on green cardstock.

z

x

x

# Letters With Slanted Lines

v, w, y, x, z

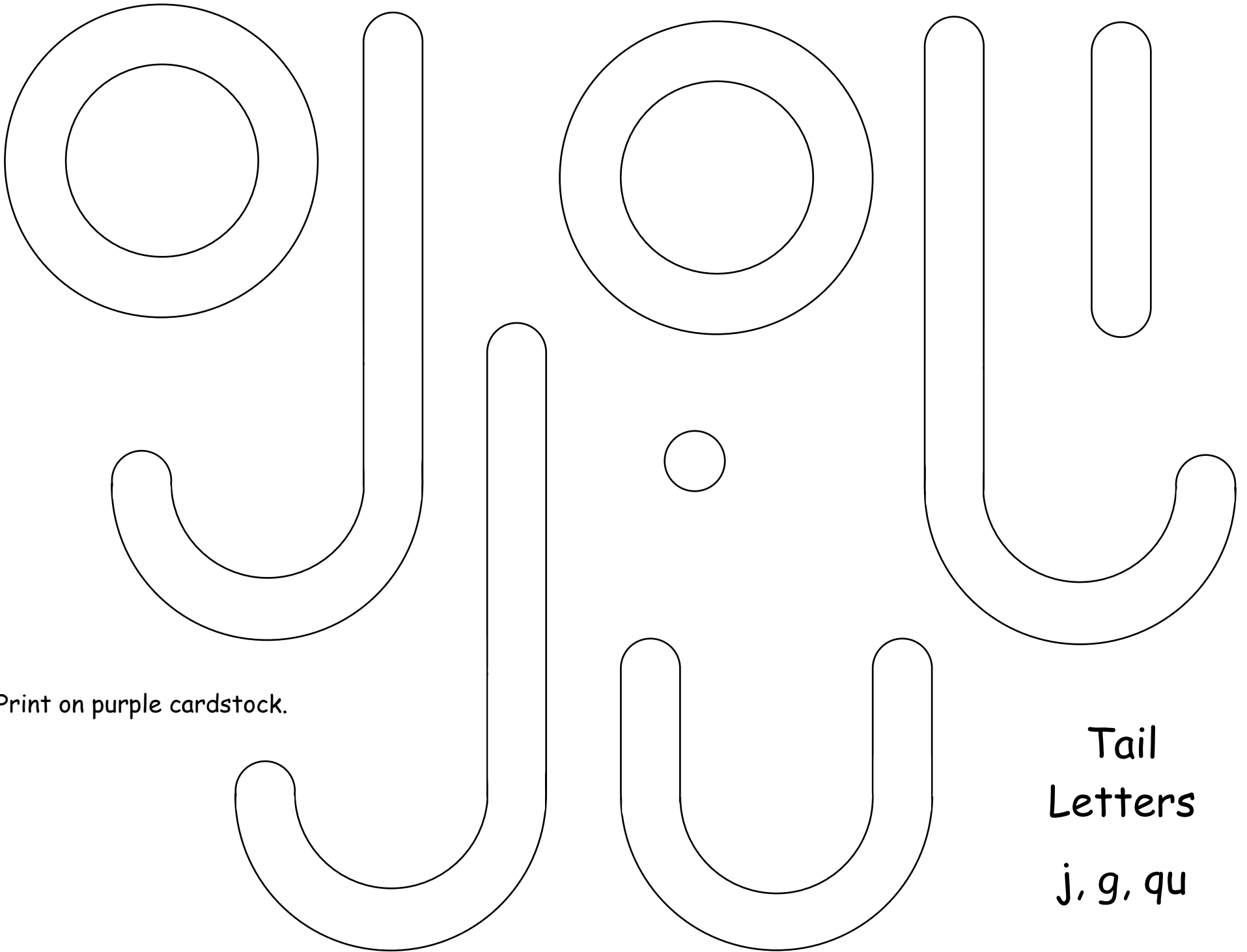

Print on purple cardstock.

Tail  
Letters  
j, g, qu

Print on blue cardstock.

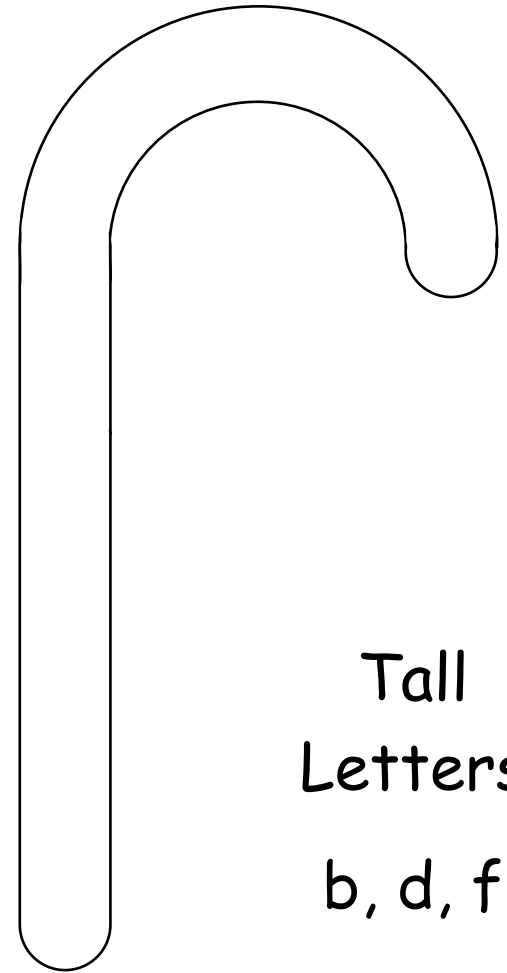
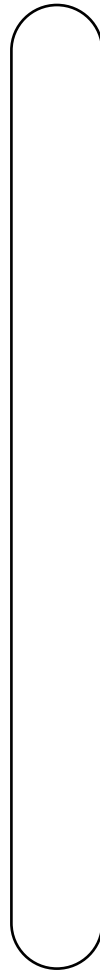
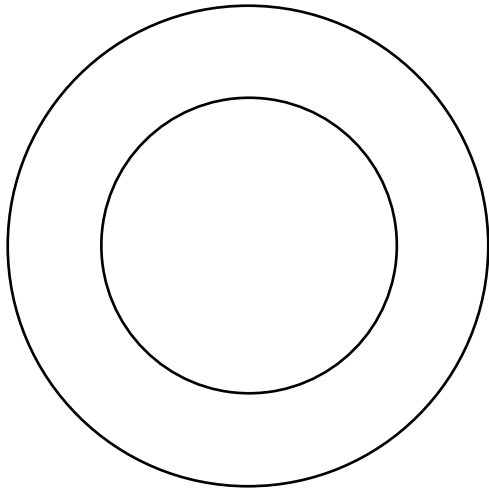
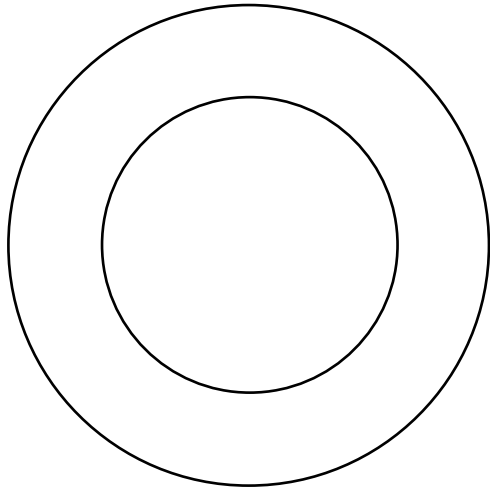
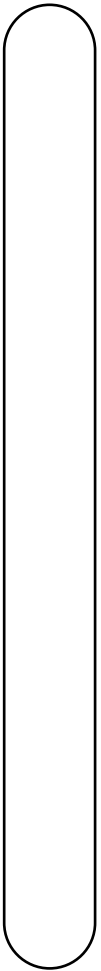

Tall  
Letters  
b, d, f

Tall  
Letters  
h, k, l, t

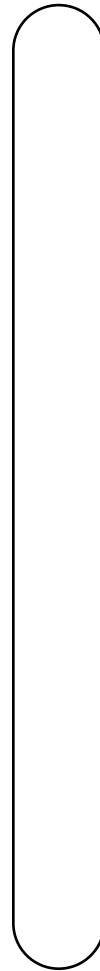
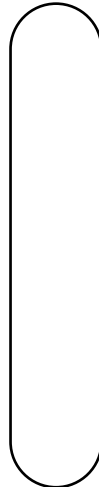
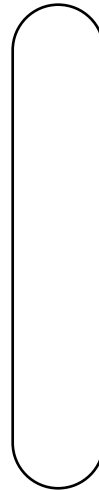
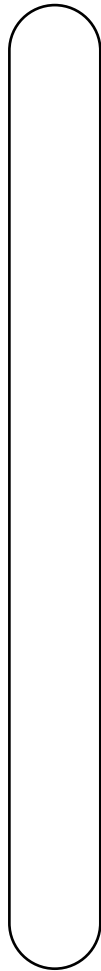
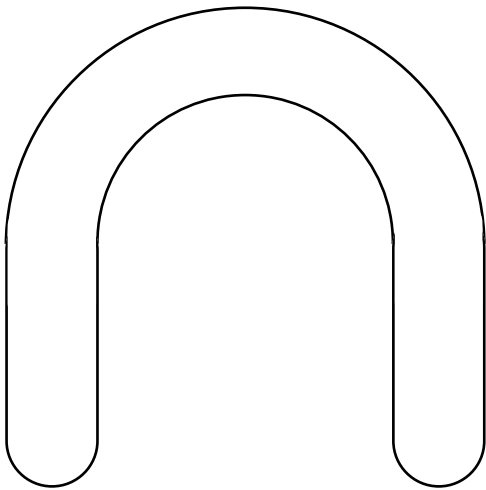
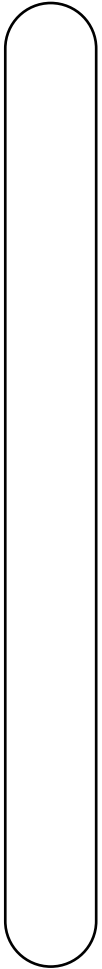

Print on blue cardstock.

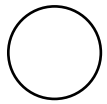
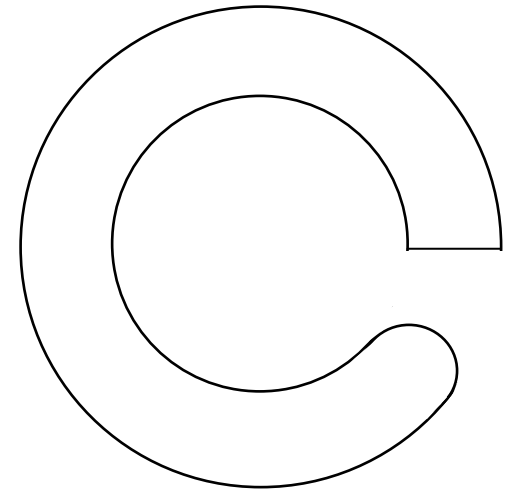
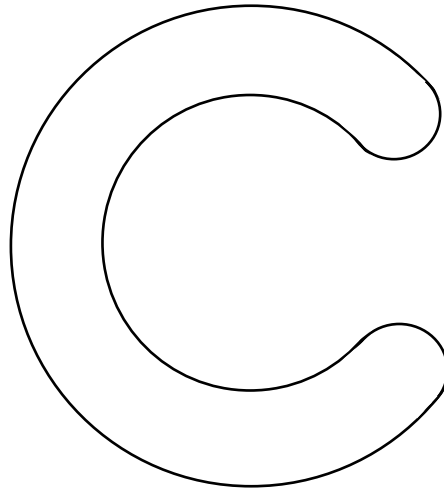
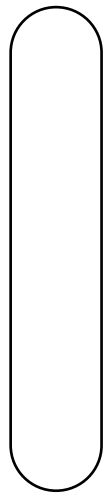
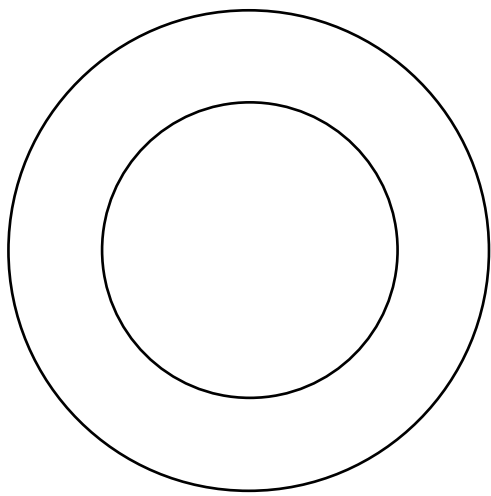

Print on red cardstock.

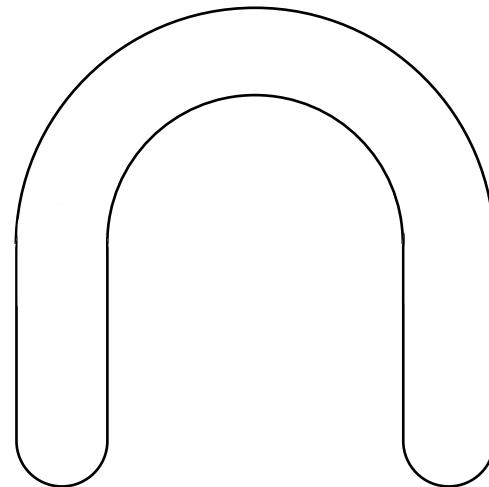
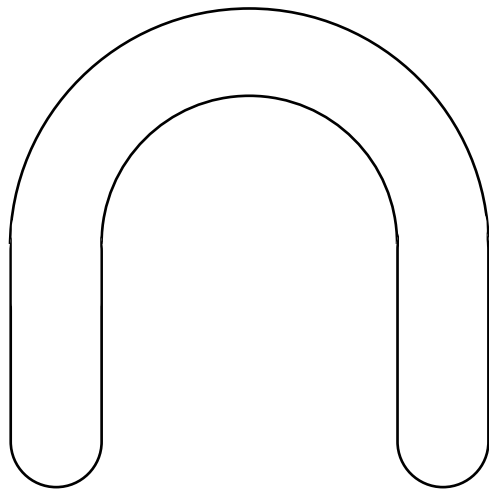
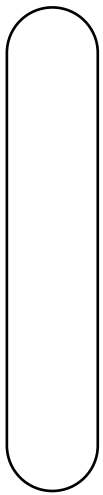
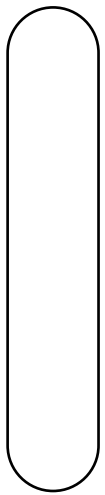

Short  
Letters  
a, c, e, i, m



Print on red cardstock.

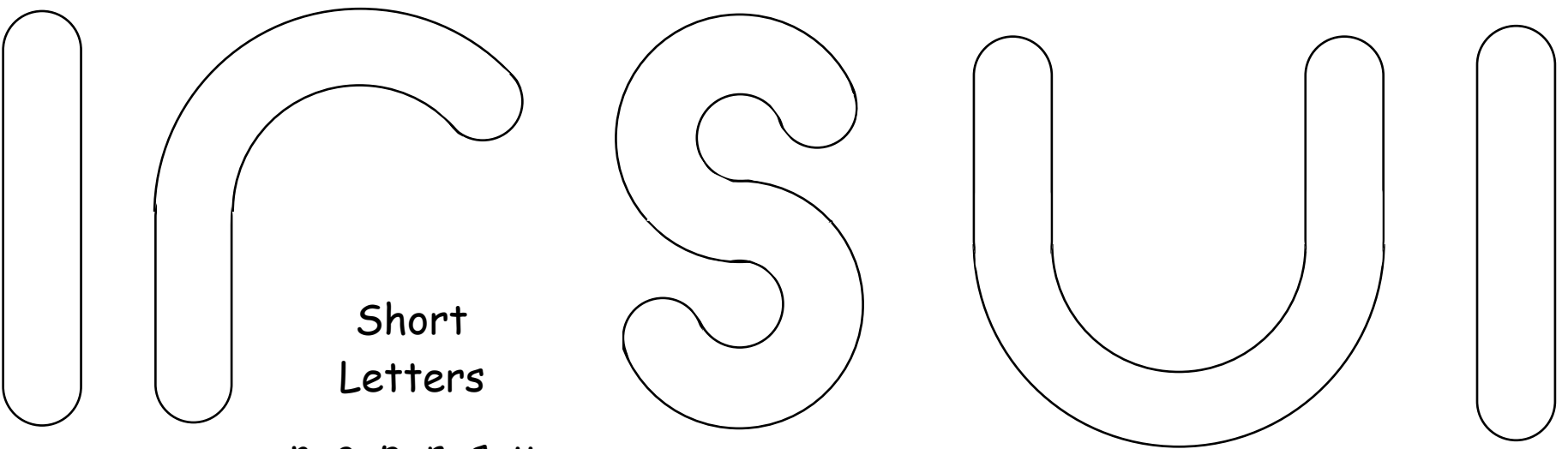
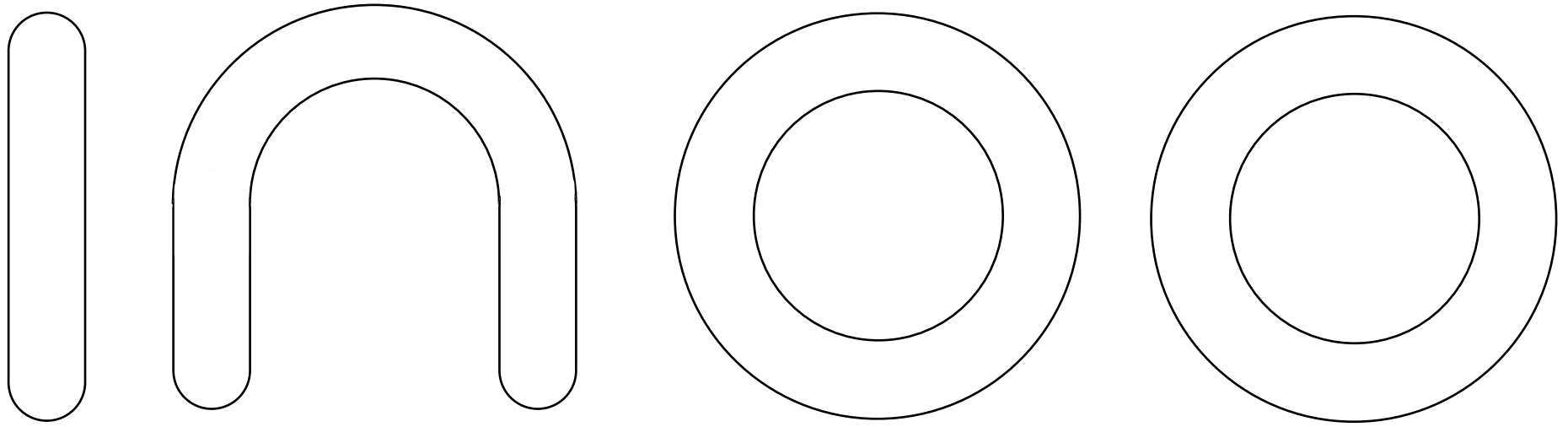

Short  
Letters

n, o, p, r, s, u

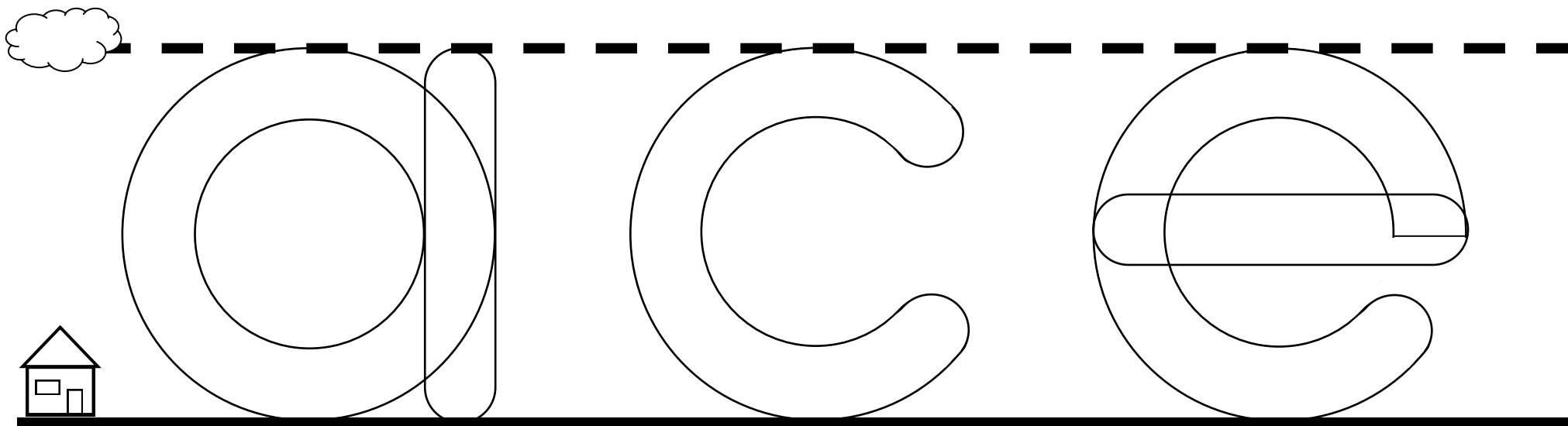

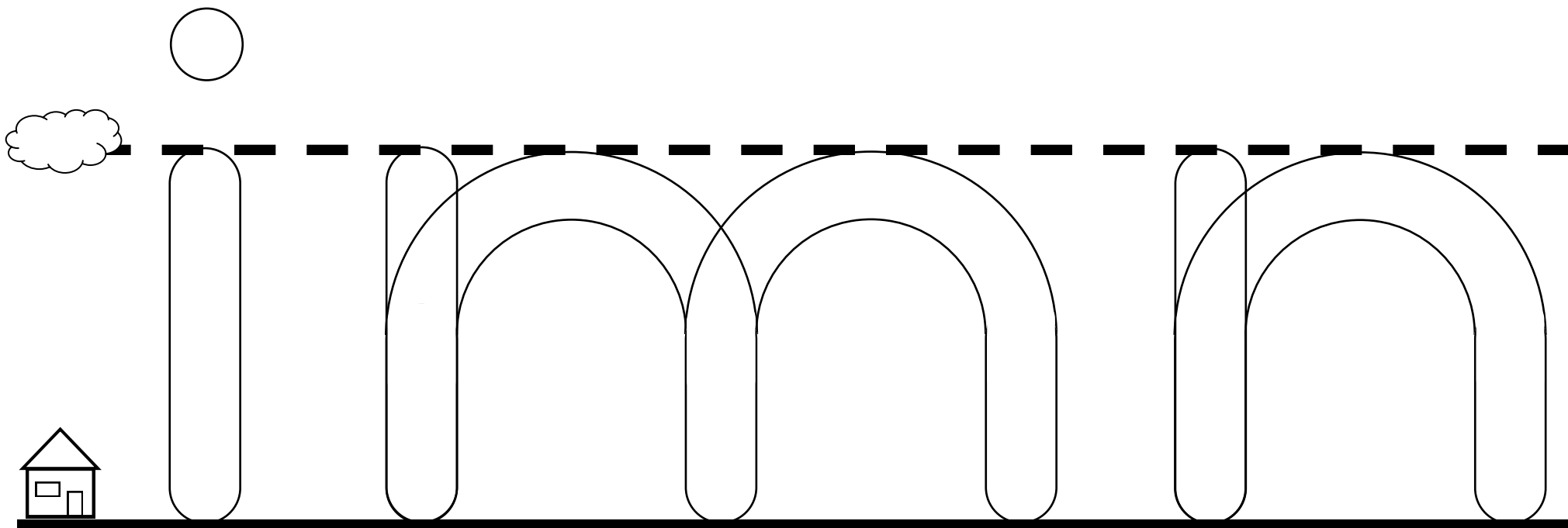
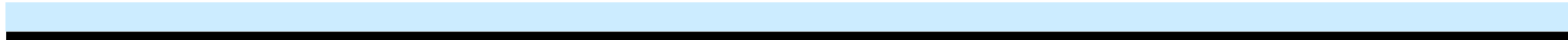

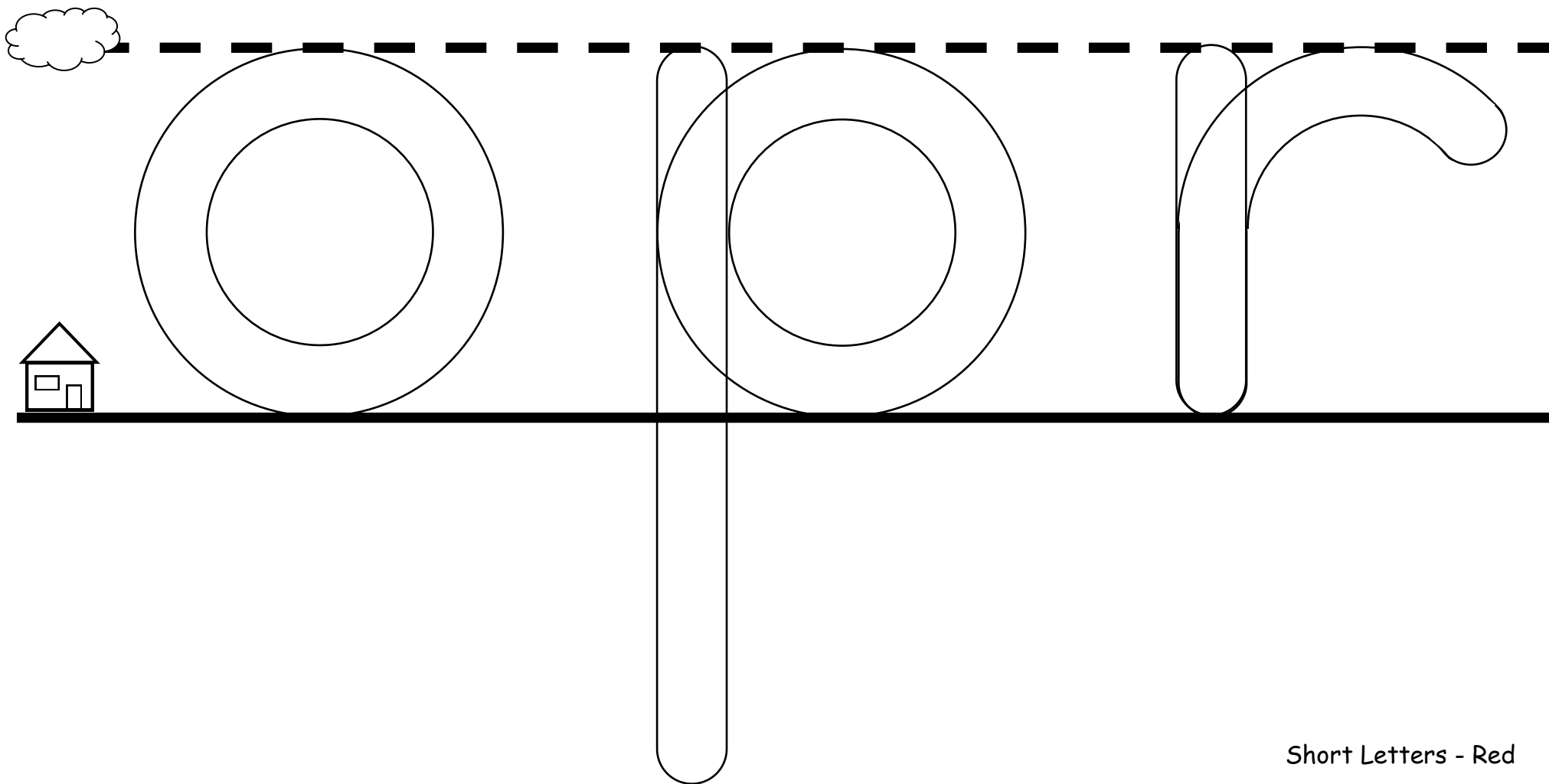

Short Letters - Red



S

u



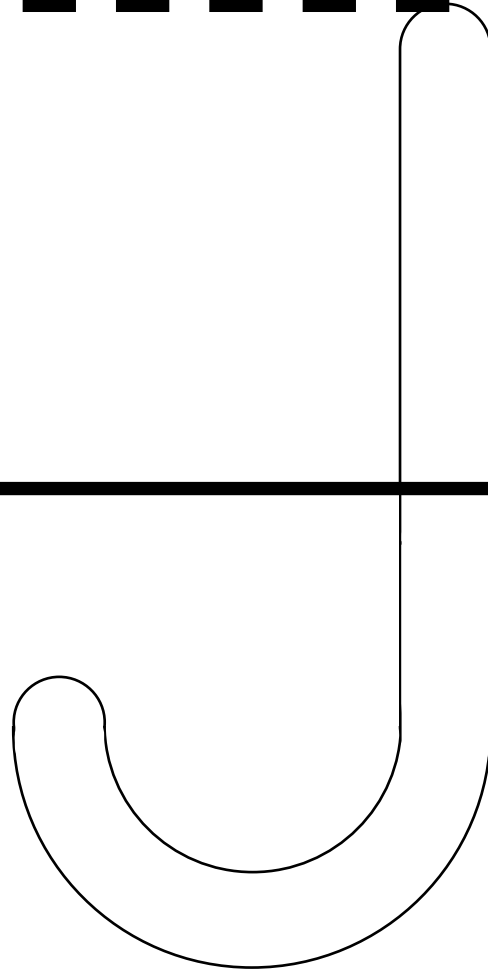
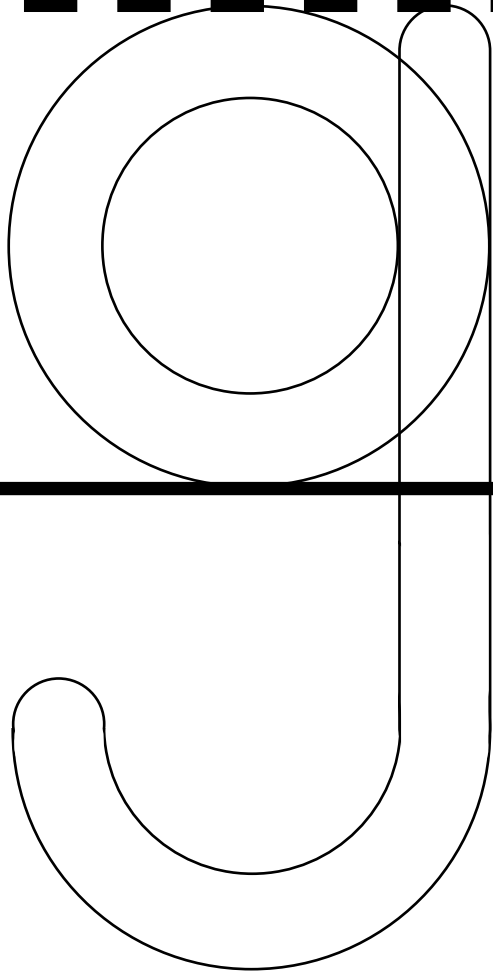
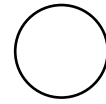

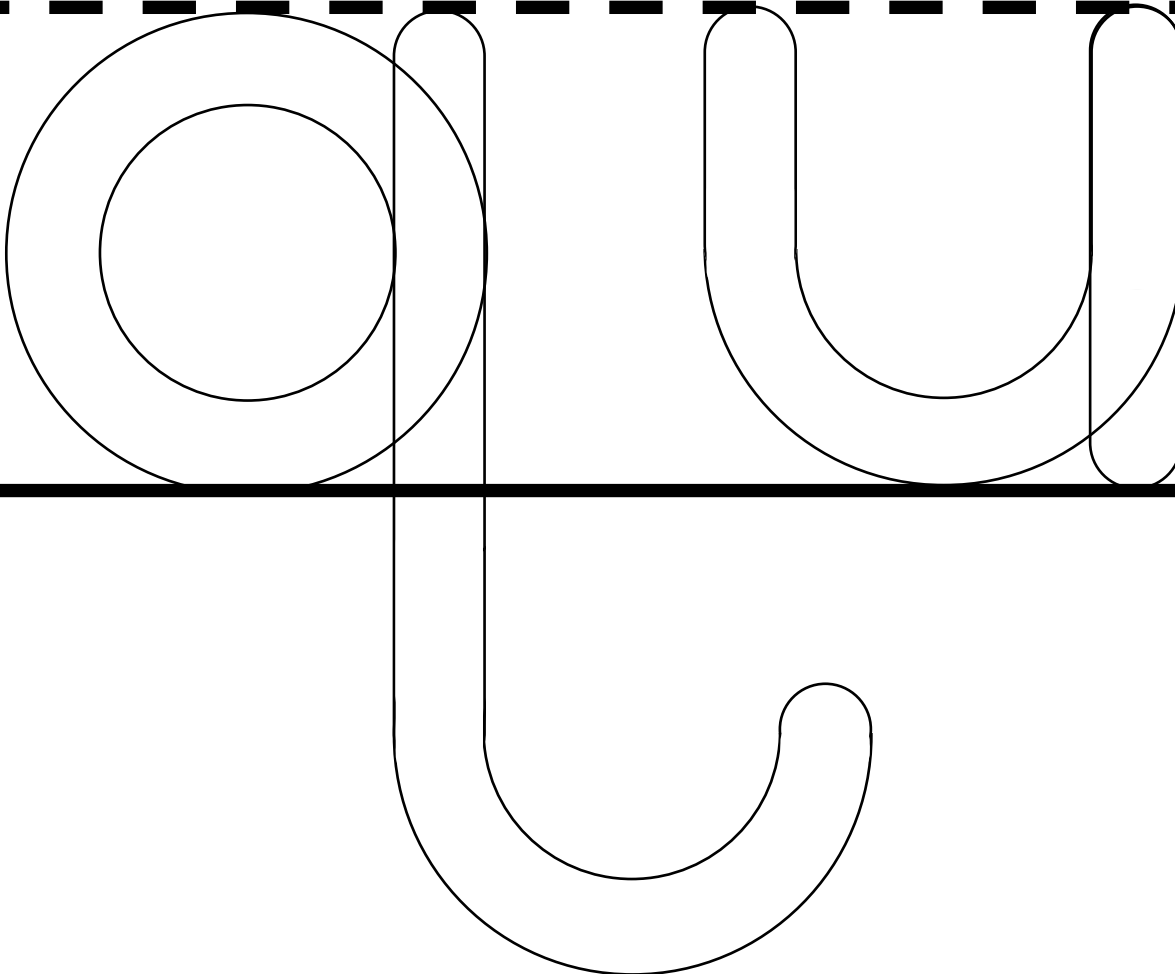

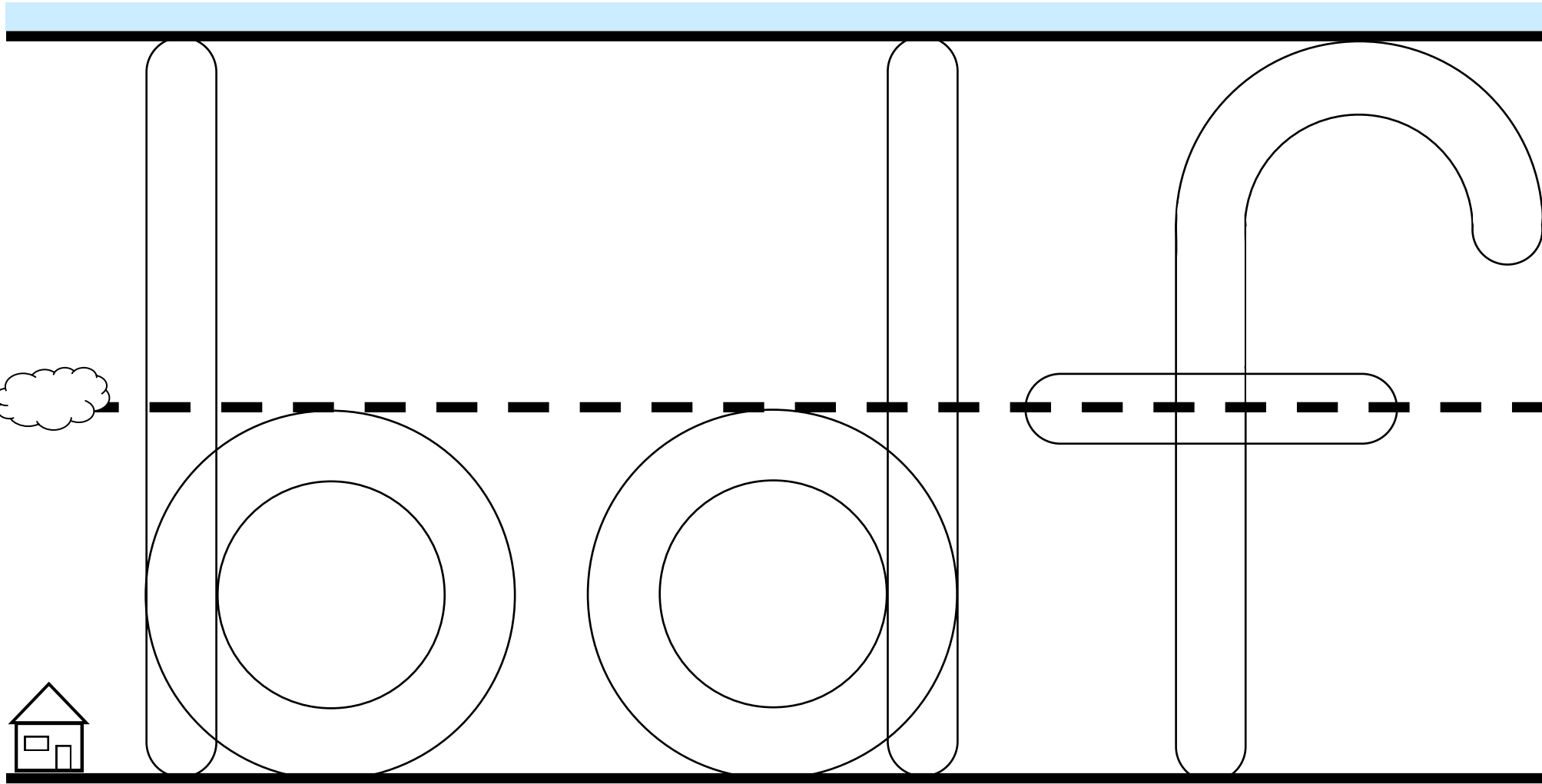



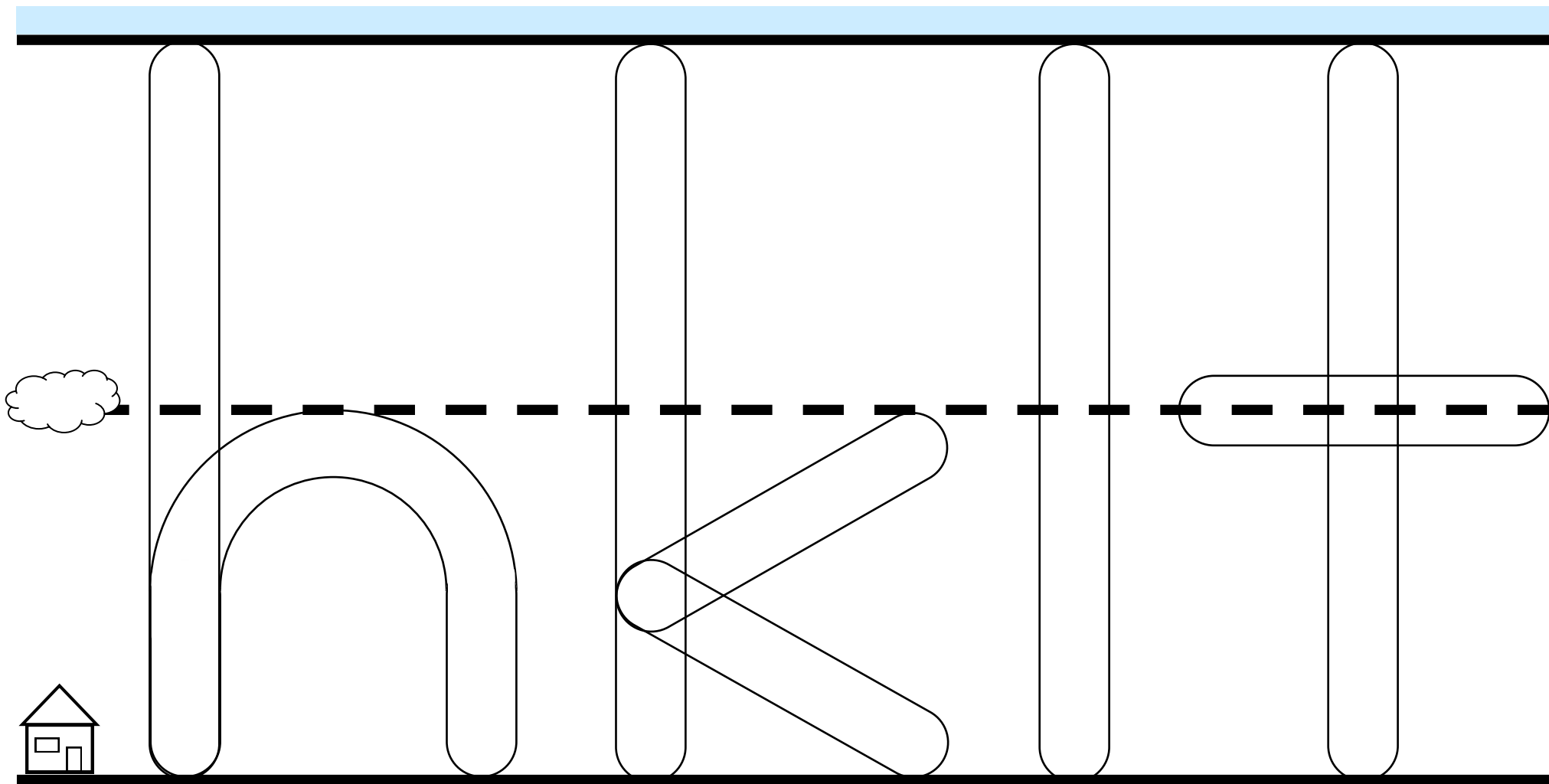

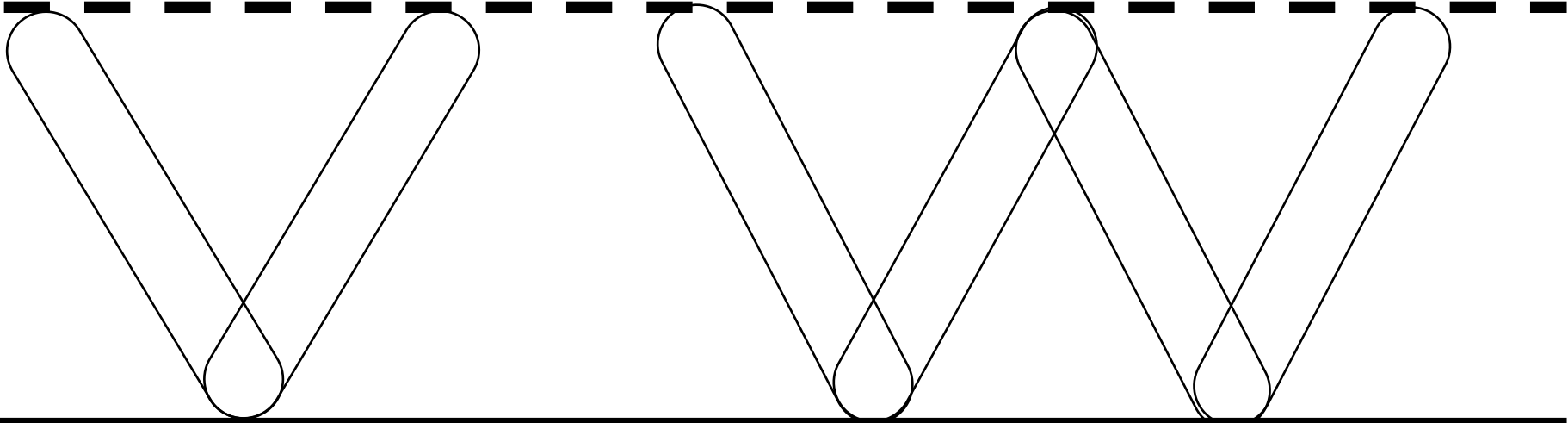

Slanted Lines - Green

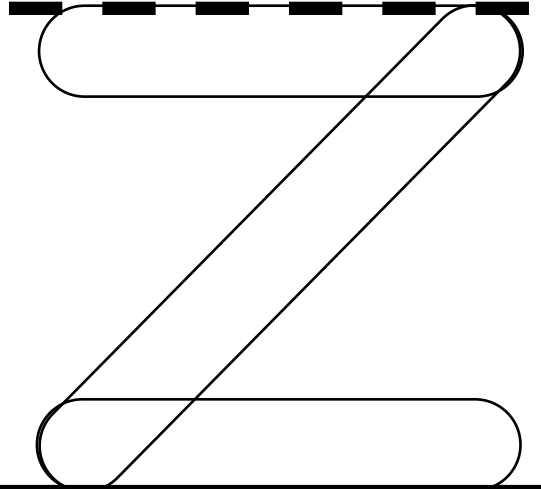
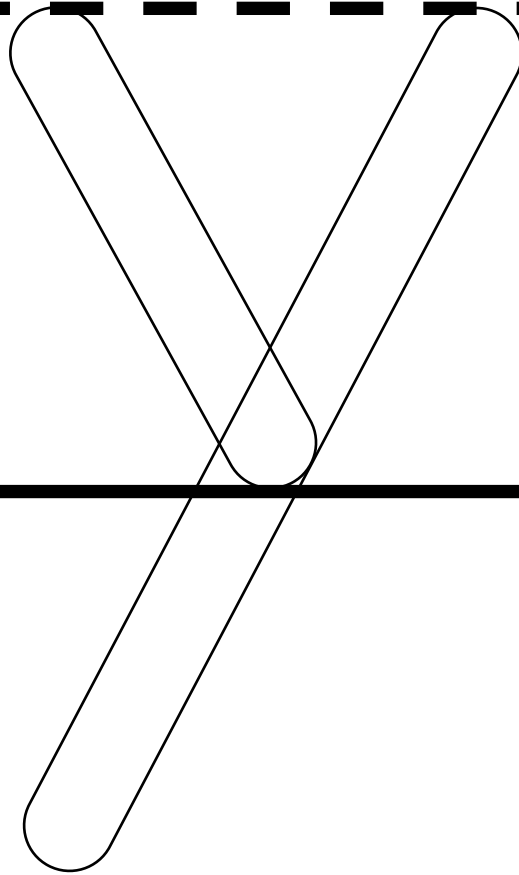
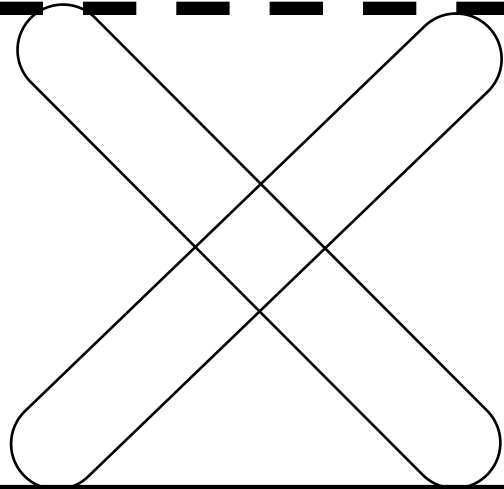



o o c

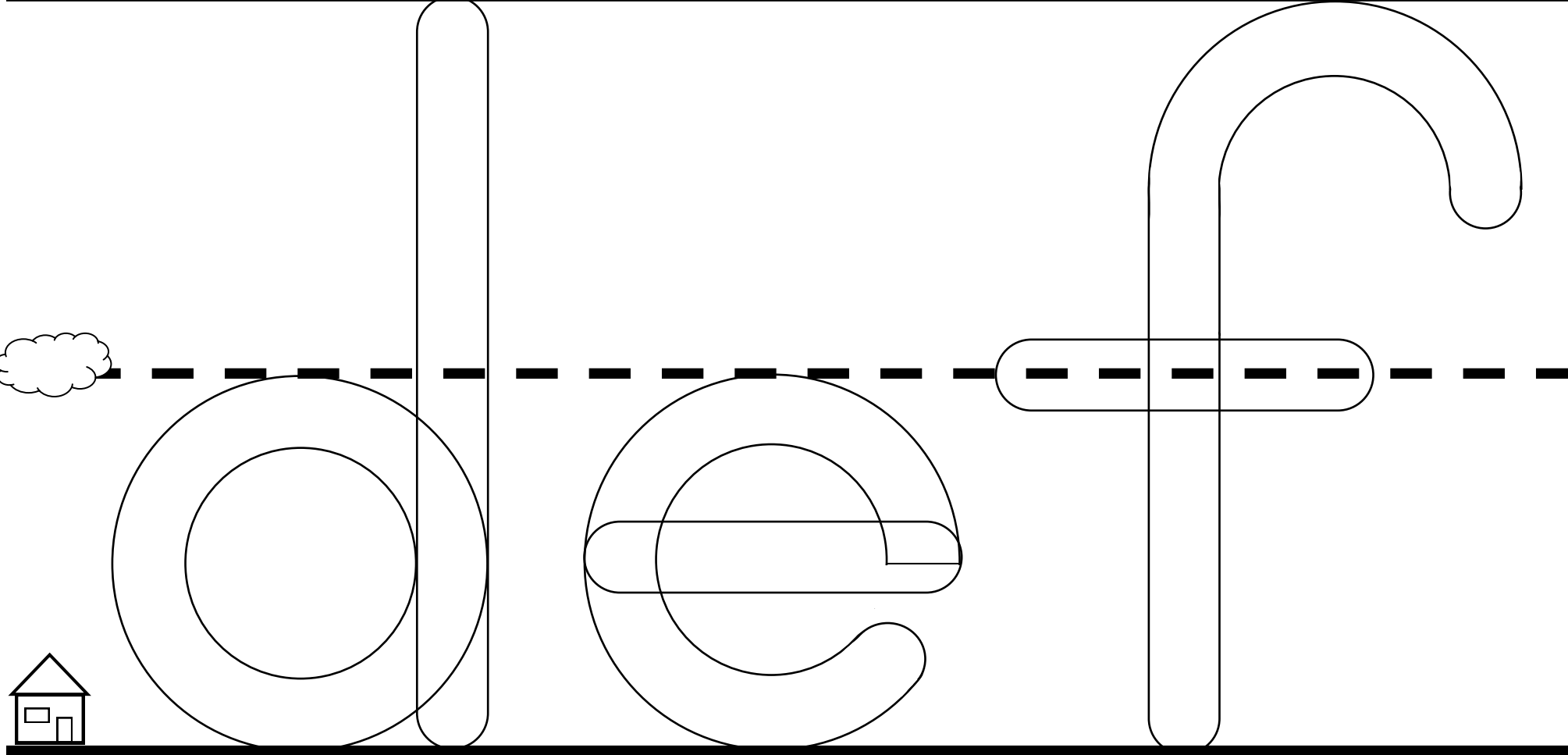

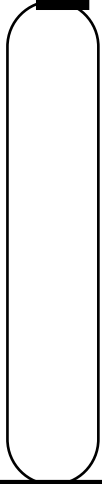
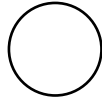
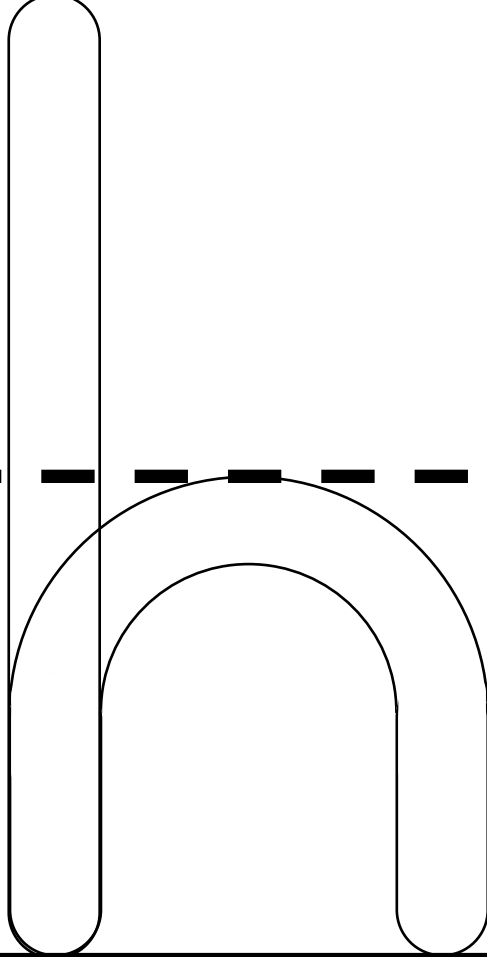
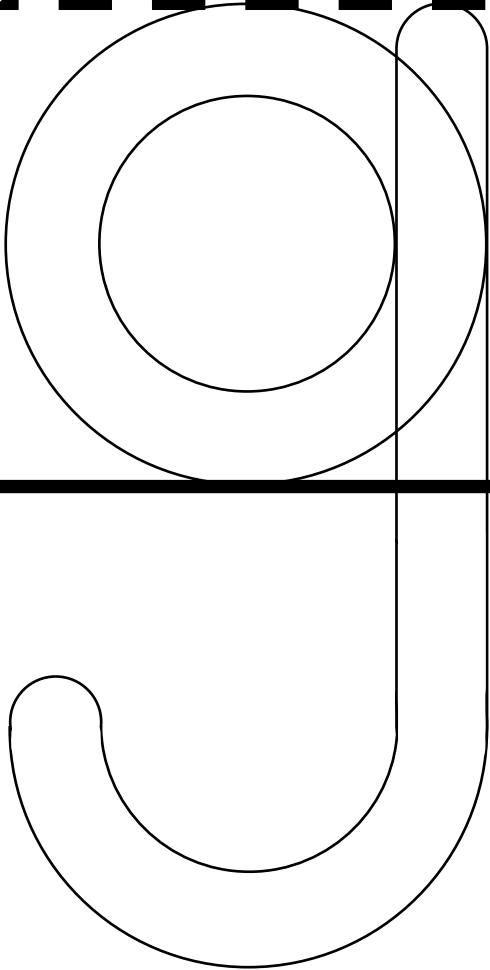
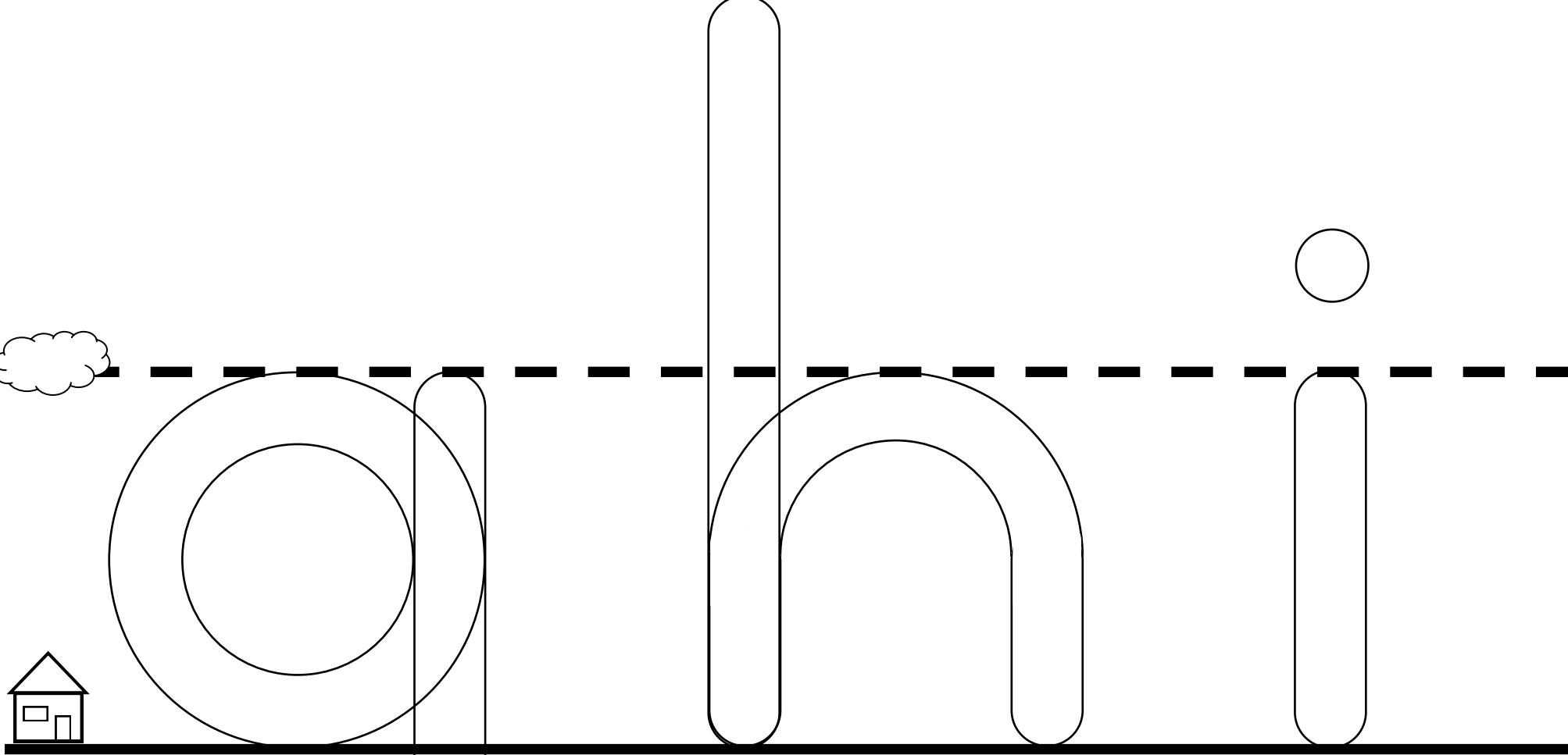
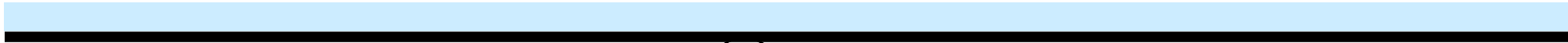



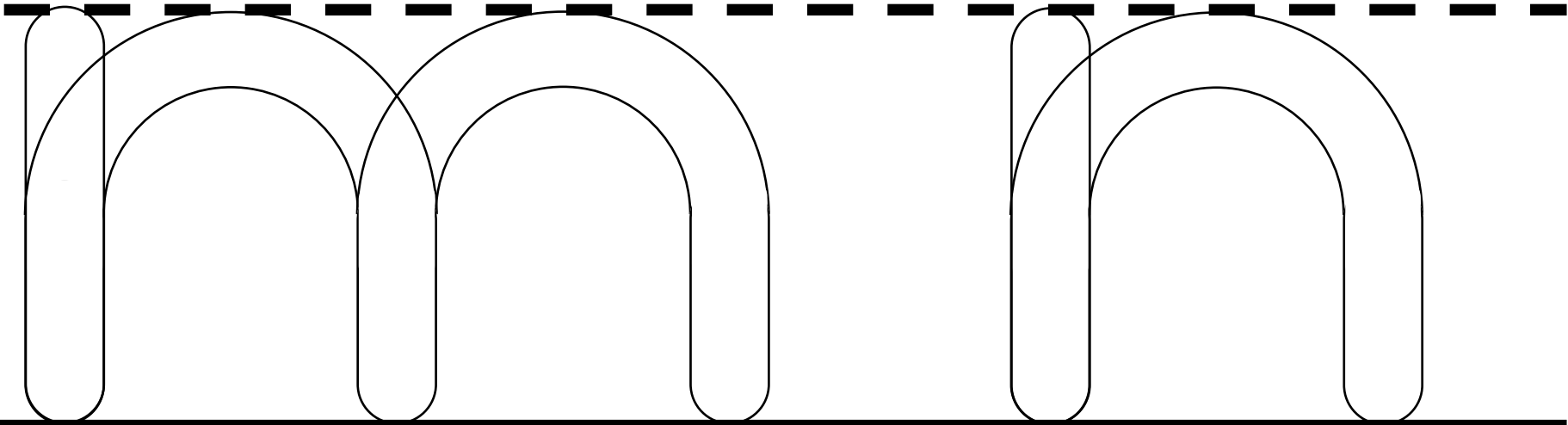



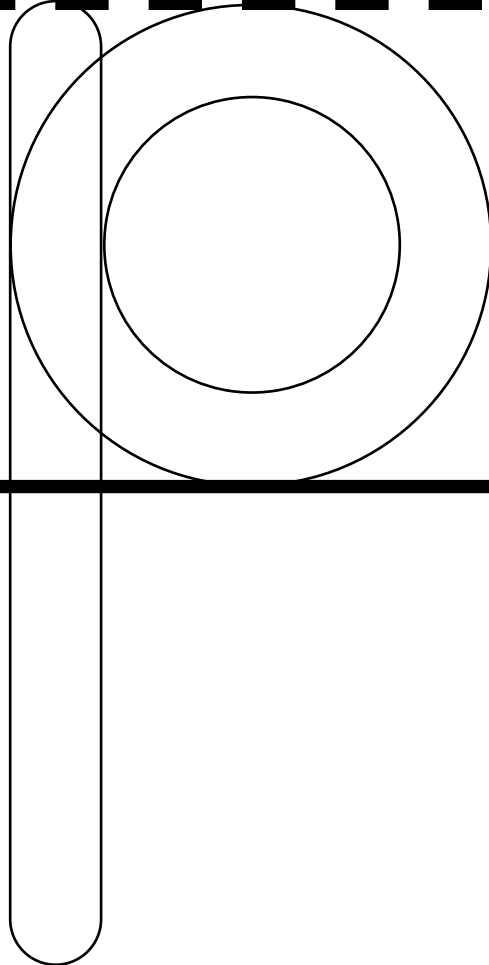
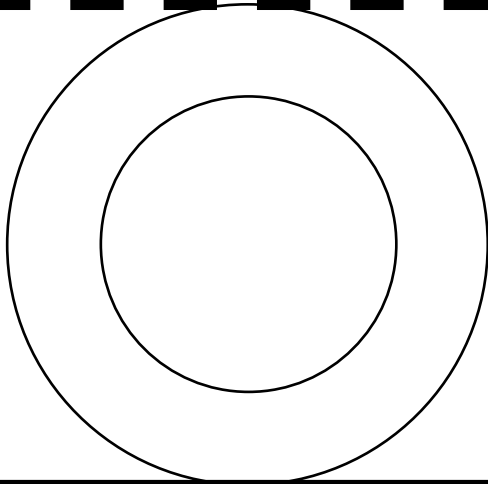

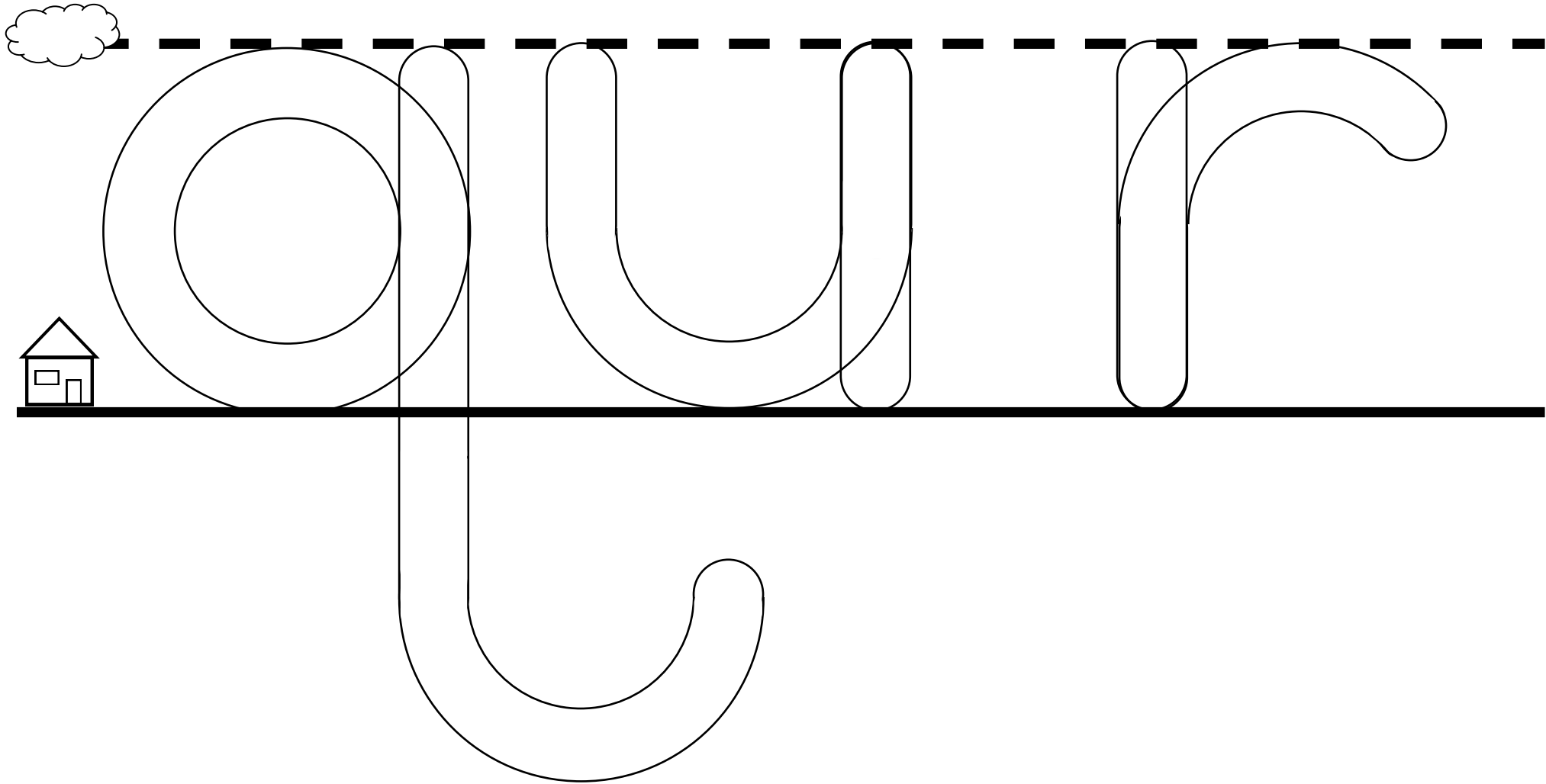

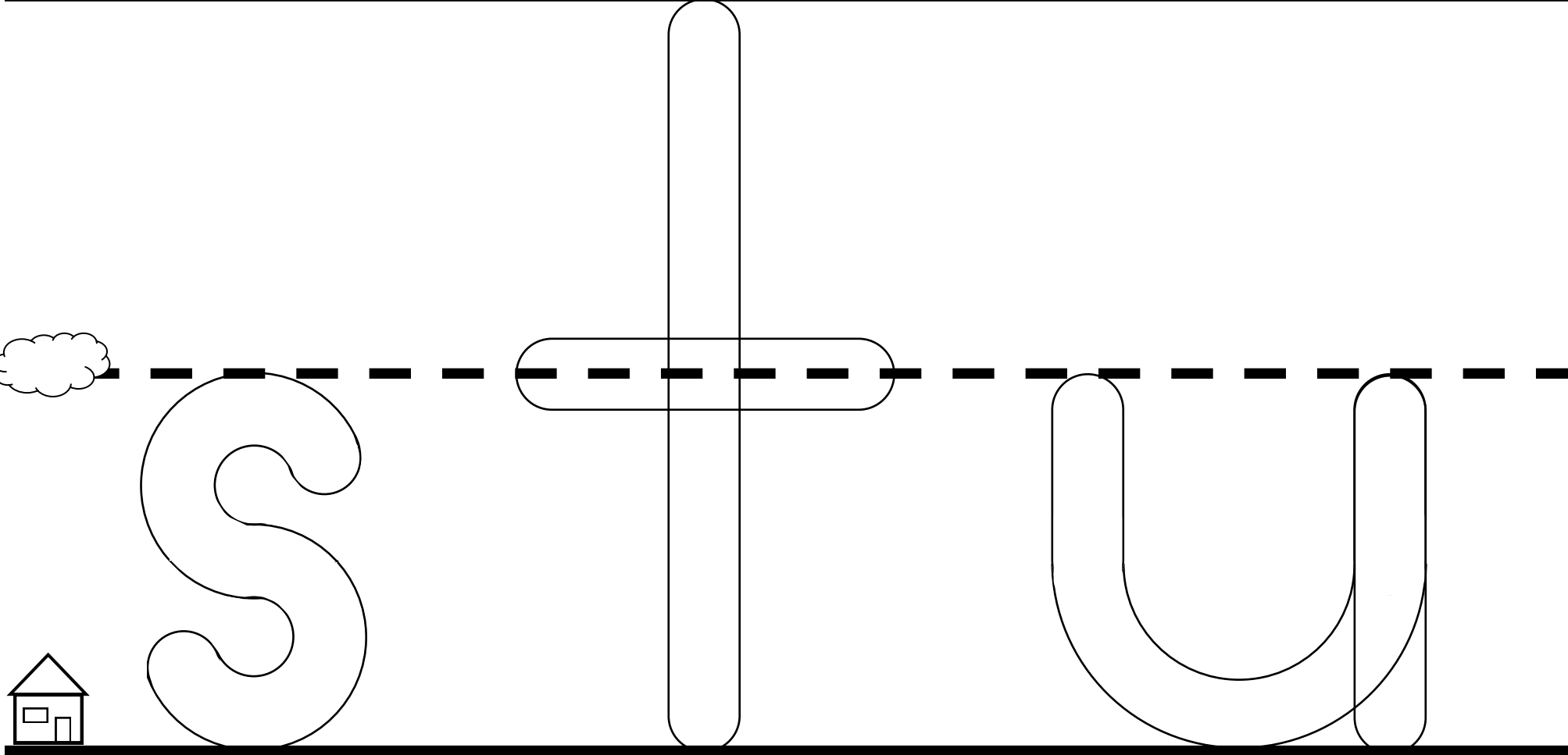

S

T

U

